

显示模式: TN反射正显灰膜  
 驱动条件: 3.3V, 1/4Duty, 1/3Bias  
 视角: 6  
 温度范围: -20,70度工作, -30,80度储存  
 尺寸: 长30.0\*宽15.0mm, 反射模式

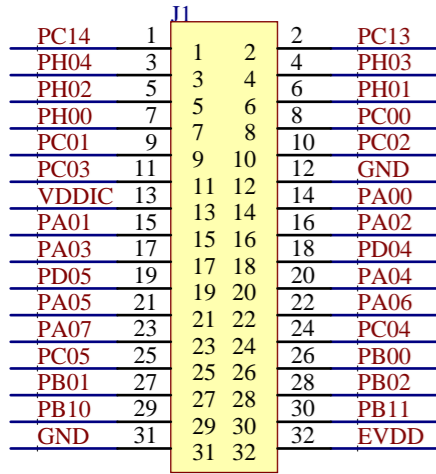

HDR2X16

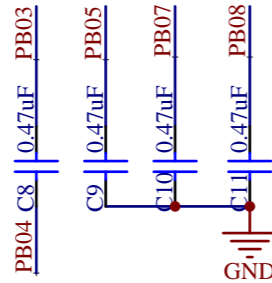
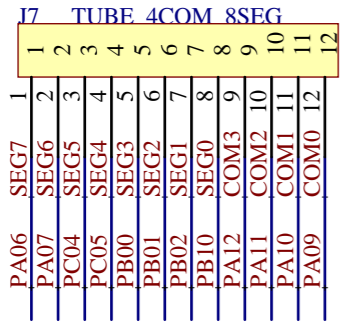
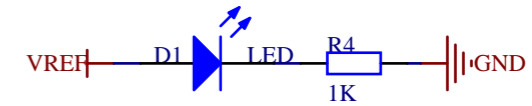
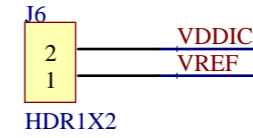
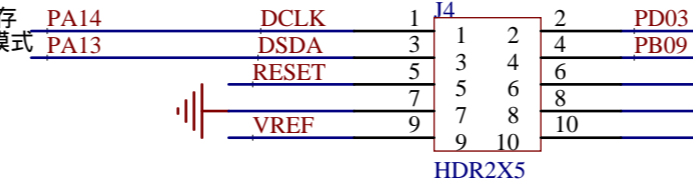
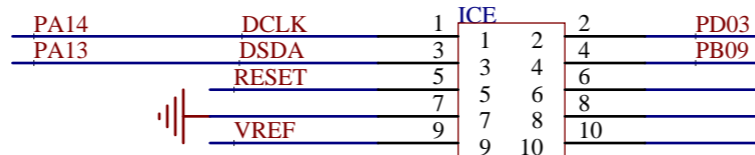
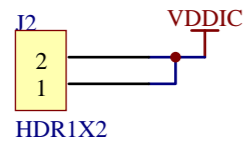

HDR1X2

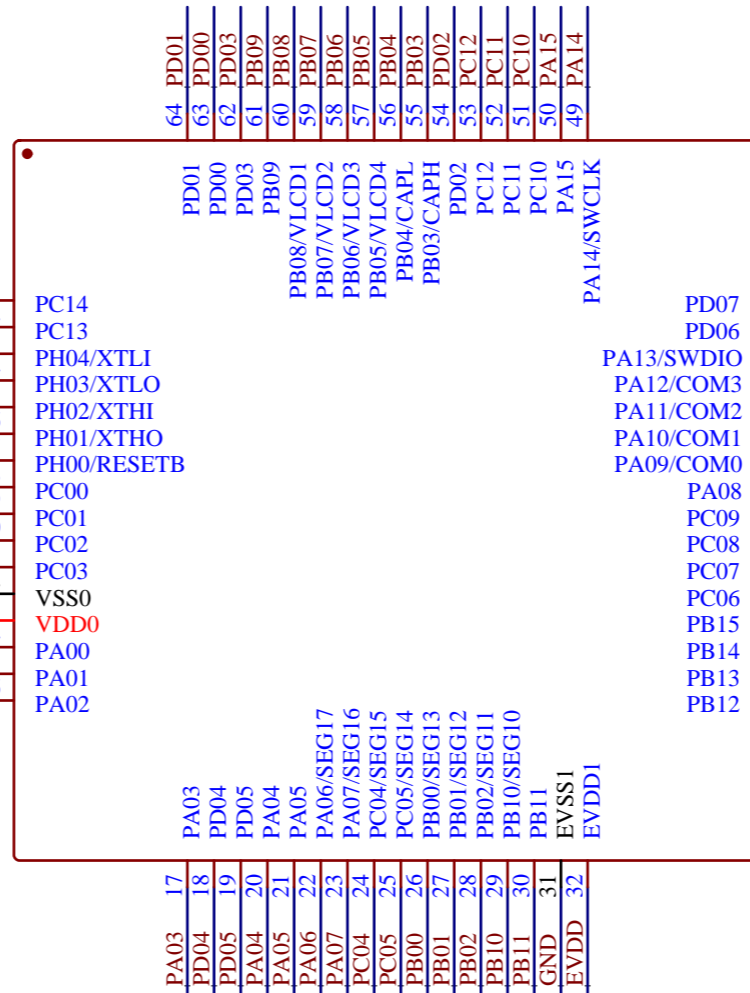
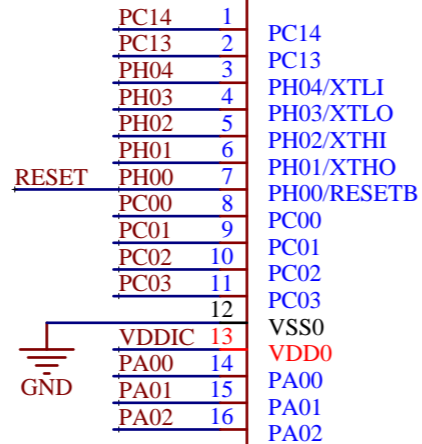

U1  
BAT32G127GH64FB

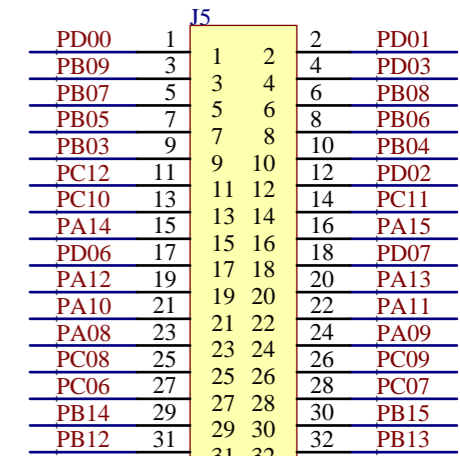

HDR2X16

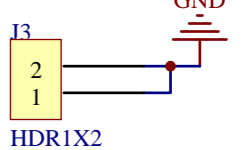

HDR1X2

